

# U NEED HARDWARE

ITEM# HD048

48" HEAVY DUTY SURFACE BOLT, SOLID BRASS

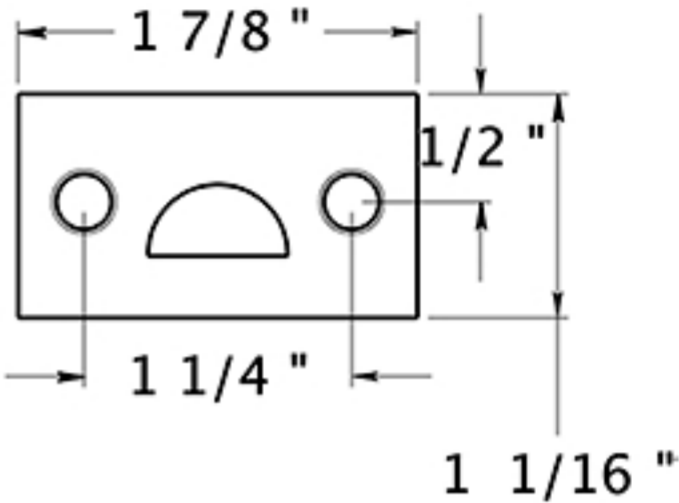
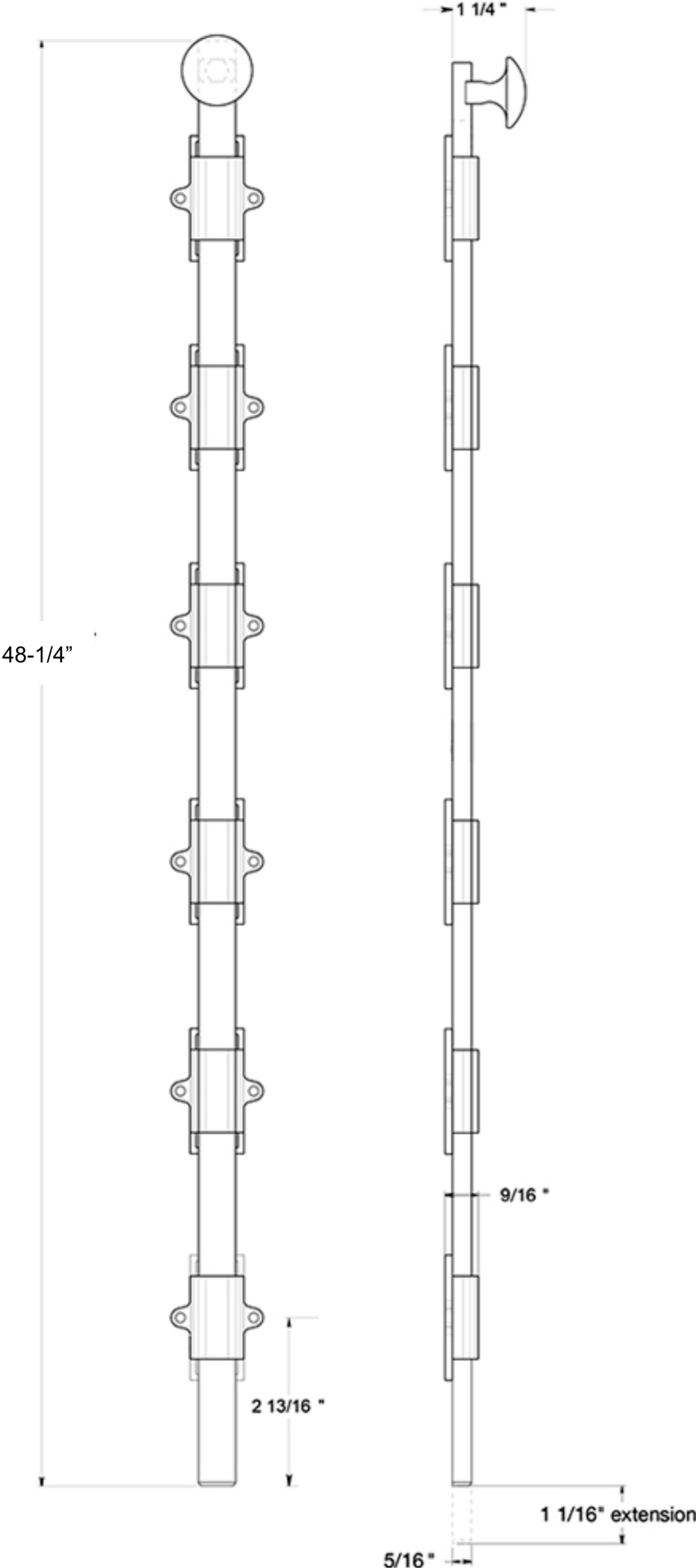

Mortise Strike

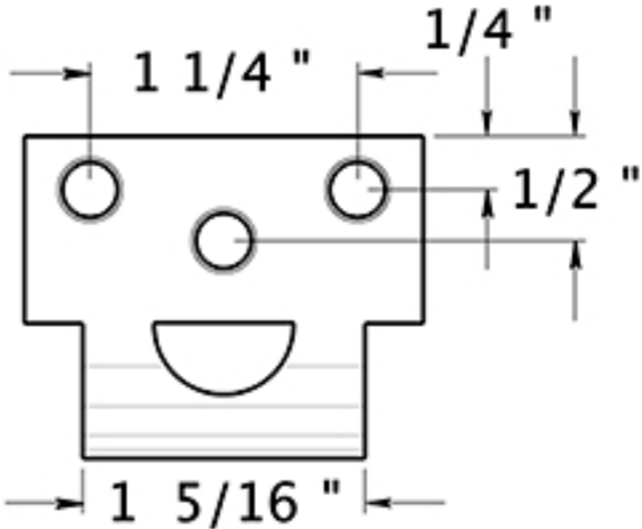

Universal Strike

DRAWING NOT TO SCALE

Note: U NEED HARDWARE Co. reserves the right to constantly improve its products and is not responsible for differences between the product in-hand and the specifications contained in this drawing. We do not recommend pre-drilling holes or pre-cutting woods or metals based on the drawing info. If the accuracy of the specifications has not been measured and re-confirmed by the actual product in-hand.